

ST Cloud Control to BACnet MS/TP or IP or Modbus RTU and TCP Gateway

Item number: INSTCMBG0080000

Intesis ST Cloud Control was a bidirectional cloud-based solution to monitor and control any BACnet or Modbus device, whether from a web-based dashboard or an end-user-oriented app. The solution allowed the integration of up to 4 devices, with up to 12 widgets per device.



Discontinued with no replacement available

Features and benefits

- ✓ **Cloud-based remote control and monitoring system**
ST Cloud Control is a cloud-based system for remote control and monitoring of BACnet/Modbus devices.
- ✓ **Simultaneous Support for Modbus TCP and RTU**
Both Modbus TCP and Modbus RTU can be supported simultaneously by the gateway.
- ✓ **Native Android and iOS App**
Another available control method is via a native app developed for both Android and iOS platforms.
- ✓ **Integration with Intesis MAPS configuration tool**
Once the gateway is installed, it is configured using the PC-based Intesis MAPS configuration tool.
- ✓ **Support for BACnet/IP and BACnet MS/TP**
The gateway supports both BACnet/IP and BACnet MS/TP protocols.
- ✓ **End-user-oriented, auto-generated web dashboards**
The gateway's interface consists of easy-to-use, end-user-oriented, auto-generated web dashboards.
- ✓ **Automatic updates**
Updating is really simple, as the delivery of updates is automatic.
- ✓ **Configuration through IP (Console) port**
Configuration can be carried out through the gateway's IP (Console) port.

ST Cloud Control to BACnet MS/TP or IP or Modbus RTU and TCP Gateway



General	
Net Width (mm)	53
Net Height (mm)	58
Net Depth (mm)	93
Net Weight (g)	93
Packed Width (mm)	120
Packed Height (mm)	80
Packed Depth (mm)	100
Packed Weight (g)	194
Operating Temperature °C Min	0
Operating Temperature °C Max	60
Input Voltage (V)	9-36 VDC / 24 VAC / 50-60 Hz / 0.140 A / 1.7 W
Power Connector	3-pole
Capacity	Up to 8 BACnet or Modbus devices with up to 96 widgets in the cloud.
Installation Conditions	This gateway is designed to be mounted inside an enclosure. If the unit is mounted outside an enclosure, precautions should always be taken to prevent electrostatic discharge to the unit. When working inside an enclosure (e.g., making adjustments, setting switches, etc.), typical anti-static precautions should always be followed before touching the unit.
Content of Delivery	Intesis gateway and installation manual.
Not Included (in delivery)	Power supply not included.
Mounting	DIN rail mount (bracket included)
Housing Materials	Plastic
Warranty (years)	3 years

ST Cloud Control to BACnet MS/TP or IP or Modbus RTU and TCP Gateway



General

Packaging Material	Cardboard
--------------------	-----------

Identification and Status

Product ID	INSTCMBG0080000
------------	-----------------

Country of Origin	Spain
-------------------	-------

HS Code	8517620000
---------	------------

Export Control Classification Number (ECCN)	EAR99
---	-------

Physical Features

Connectors / Input / Output	Power supply, EIA-485, Ethernet.
-----------------------------	----------------------------------

Certifications and Standards

ETIM Classification	EC001604
---------------------	----------

WEEE Category	IT and telecommunications equipment
---------------	-------------------------------------

ST Cloud Control to BACnet MS/TP or IP or Modbus RTU and TCP Gateway



Use Case

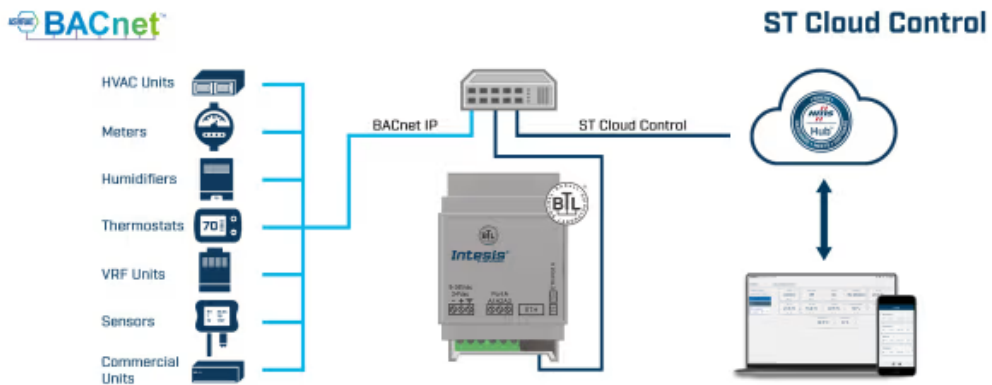

Integration example.

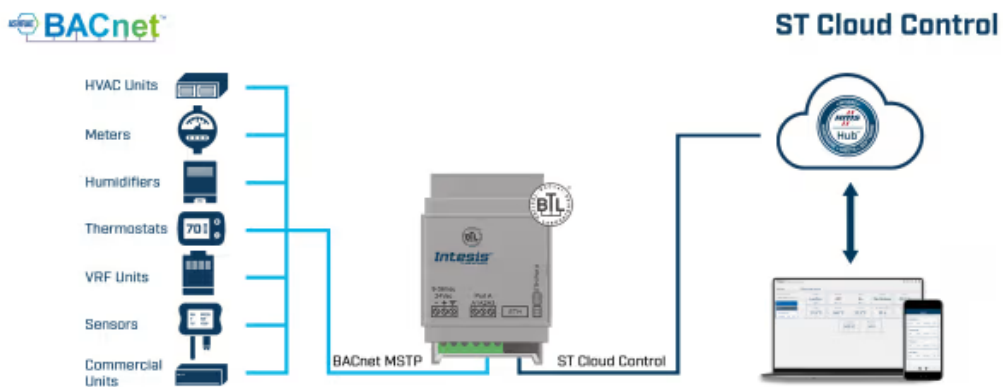

Integration example.

ST Cloud Control to BACnet MS/TP or IP or Modbus RTU and TCP Gateway



Use Case

