

M-BUS to BACnet/IP & MS/TP Server Gateway

Item number: INBACMEB0200000

Integrate any M-Bus device with a BACnet BMS or any BACnet IP or BACnet MS/TP controller. This integration aims to make M-Bus devices, their registers, and resources accessible from a BACnet-based control system or device as if they were a part of the BACnet system and vice versa.



M-BUS to BACnet/IP & MS/TP - 20 devices

Features and benefits

- ✓ **Support for both BACnet/IP and BACnet MS/TP**
The gateway supports both BACnet/IP and BACnet MS/TP protocols.
- ✓ **Commissioning-friendly approach with Intesis MAPS**
Templates can be imported and reused as often as needed, significantly reducing commissioning time.
- ✓ **Configuration through IP (Console) port**
Configuration can be carried out through the gateway's IP (Console) port.
- ✓ **Embedded M-Bus level converter**
An M-Bus level converter is embedded in the gateway, so no external one is required.
- ✓ **Easy integration with Intesis MAPS**
The integration process is quickly and easily managed using the Intesis MAPS configuration tool.
- ✓ **Configuration tool and gateway automatic updates**
Both the Intesis MAPS configuration tool and the gateway's firmware can receive automatic updates.
- ✓ **Automatic meter detection and register discovery**
A scan function is available for automatic identification of M-Bus devices and registers discovery.
- ✓ **BACnet Advanced features - calendars, schedules...**
BACnet's advanced features, such as calendars, trend logs, schedules, and more, are available.

M-BUS to BACnet/IP & MS/TP Server Gateway



General	
Net Width (mm)	88
Net Height (mm)	90
Net Depth (mm)	58
Net Weight (g)	159
Packed Width (mm)	127
Packed Height (mm)	86
Packed Depth (mm)	140
Packed Weight (g)	184
Operating Temperature °C Min	0
Operating Temperature °C Max	60
Storage Temperature °C Min	-30
Storage Temperature °C Max	60
Power Consumption (W)	13
Input Voltage (V)	24VDC +/-10%.
Power Connector	3-pole
Configuration	Intesis MAPS
Capacity	Up to 20 meters.
Installation Conditions	This gateway is designed to be mounted inside an enclosure. If the unit is mounted outside an enclosure, precautions should always be taken to prevent electrostatic discharge to the unit. When working inside an enclosure (e.g., making adjustments, setting switches, etc.), typical anti-static precautions should always be followed before touching the unit.
Content of Delivery	Intesis Gateway, Installation Manual, USB Configuration cable.



General

Not Included (in delivery)	Power supply not included.
Mounting	DIN rail mount (bracket included), Wall mount
Housing Materials	Plastic
Warranty (years)	3 years
Packaging Material	Cardboard

Identification and Status

Product ID	INBACMEB0200000
Country of Origin	Spain
HS Code	8517620000
Export Control Classification Number (ECCN)	EAR99

Physical Features

Connectors / Input / Output	Power supply, MBUS, Ethernet, Console port USB, USB storage, EIA-485.
LED Indicators	Gateway and communication status.
DIP & Rotary Switches	EIA-485 serial port configuration.
Battery Description	Manganese Dioxide Lithium button battery.

Certifications and Standards

ETIM Classification	EC001604
WEEE Category	IT and telecommunications equipment



Use Case

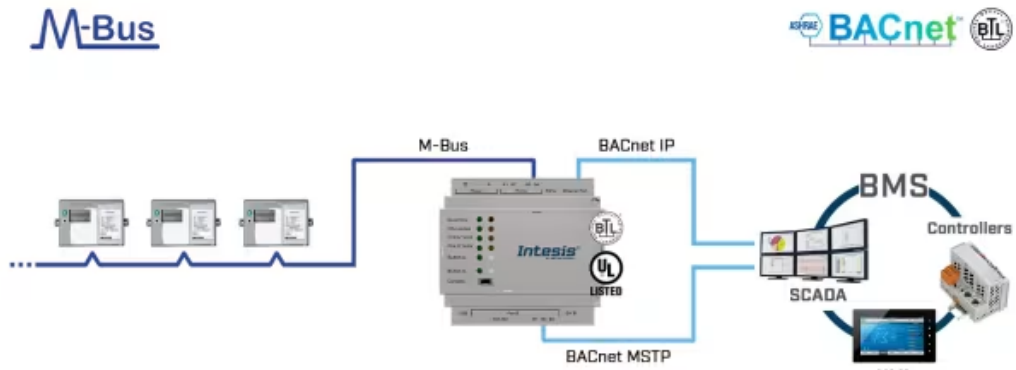

Integration example.

