



KNX TP to ASCII IP & Serial Server Application

Item number: IN701KNX1000000

Integrate any KNX device or installation with an ASCII BMS or any ASCII IP or ASCII serial controller. This integration aims to make KNX communication objects and resources accessible from an ASCII-based control system or device as if they were a part of the ASCII system and vice versa.

KNX to ASCII IP & ASCII Serial - 100 points

Features and benefits

- ✓ **Easy integration with Intesis MAPS**
The integration process is quickly and easily managed using the Intesis MAPS configuration tool.
- ✓ **Configuration tool and gateway automatic updates**
Both the Intesis MAPS configuration tool and the gateway's firmware can receive automatic updates.
- ✓ **Control up to 3000 KNX communication objects**
Up to 3000 KNX communication objects can be controlled by the gateway.
- ✓ **ASCII bus automatic write request on value change**
When an ASCII value changes, the gateway automatically sends a write request to the ASCII bus.
- ✓ **Commissioning-friendly approach with Intesis MAPS**
Templates can be imported and reused as often as needed, significantly reducing commissioning time.
- ✓ **Support for KNX TP devices**
The gateway supports KNX TP (twisted pair) devices.
- ✓ **ASCII Serial (232/485) and ASCII IP support**
The gateway fully supports both ASCII IP and ASCII Serial (232/485).
- ✓ **Personalized ASCII strings use**
It is possible to use personalized ASCII strings on this gateway.

General	
Net Width (mm)	88
Net Height (mm)	56
Net Depth (mm)	90
Net Weight (g)	194
Packed Width (mm)	127
Packed Height (mm)	86
Packed Depth (mm)	140
Packed Weight (g)	356
Operating Temperature °C Min	-10
Operating Temperature °C Max	60
Input Voltage (V)	For DC: 9 .. 36 VDC, Max: 180 mA, 1.7 W For AC: 24 VAC ±10 %, 50-60 Hz, Max: 70 mA, 1.7 W Recommended voltage: 24 VDC, Max: 70 mA
Power Connector	3-pole
Capacity	Up to 100 points.
Installation Conditions	This gateway is designed to be mounted inside an enclosure. If the unit is mounted outside an enclosure, precautions should always be taken to prevent electrostatic discharge to the unit. When working inside an enclosure (e.g., making adjustments, setting switches, etc.), typical anti-static precautions should always be followed before touching the unit.
Content of Delivery	Intesis Gateway, Installation Manual, USB Configuration cable.
Not Included (in delivery)	Power supply not included.
Mounting	DIN rail mount (bracket included), Wall mount
Housing Materials	Plastic
Warranty (years)	3 years

General

Packaging Material	Cardboard
---------------------------	-----------

Identification and Status

Product ID	IN701KNX1000000_ASCII_KNX
-------------------	---------------------------

Country of Origin	Spain
--------------------------	-------

HS Code	8517620000
----------------	------------

Export Control Classification Number (ECCN)	EAR99
--	-------

Physical Features

Connectors / Input / Output	Power supply, KNX, Ethernet, Console port USB Mini-B type, USB storage, EIA-232, EIA-485.
------------------------------------	---

LED Indicators	Gateway and communication status.
-----------------------	-----------------------------------

Push Buttons	Factory reset.
---------------------	----------------

DIP & Rotary Switches	EIA-485 serial port configuration.
----------------------------------	------------------------------------

Battery Description	Manganese Dioxide Lithium button battery.
----------------------------	---

Certifications and Standards

ETIM Classification	EC001604
----------------------------	----------

WEEE Category	IT and telecommunications equipment
----------------------	-------------------------------------

Use Case

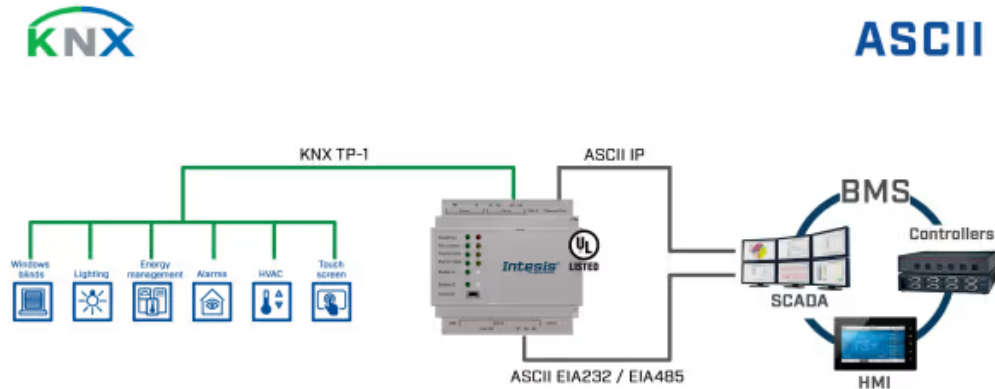

Integration example.

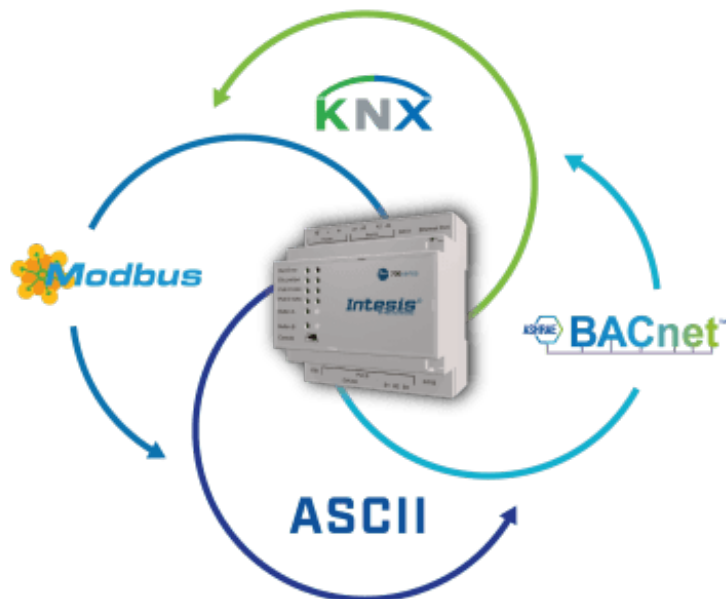

Integration example.